

## Hydraulic-Pneumatic Devices

**Pressure Boosters**

**Air Oil Tanks**

**Accumulators**

		Page
<b>Pressure Boosters</b>	<i>Principles and Operation</i>	<b>136</b>
	<i>Features</i>	<b>137</b>
	<i>Dual-Pressure Booster</i>	<b>138-139</b>
	<i>Single-Pressure Booster</i>	<b>140-141</b>
	<i>Applications</i>	<b>142</b>
	<i>Engineering Data</i>	<b>143-144</b>
<b>Air Oil Tanks</b>	<i>Features and Benefits</i>	<b>144</b>
	<i>Selection and Dimensional Data</i>	<b>145</b>
<b>Nitrogen Oil Accumulators</b>	<i>Dimensional Data</i>	<b>146</b>
	<i>Features / Application / Parts List</i>	<b>147</b>

**Milwaukee Cylinder** offers additional products to help complete your system needs. **Pressure Boosters** are ideal for limited operation applications requiring intermittent high pressure when you only have low-pressure air. **Air Oil Tanks** supplement a booster system by providing a source of low pressure oil, while also providing an outlet for entrapped air. **Accumulators** can improve overall system efficiency.

## Example of How a Booster Works



1. Low pressure air enters the input section of the booster. It pushes against a large area piston. For example, if a 100 PSI air supply pushes against a 4" diameter piston, it is working against an area of approximately 12.6 square inches, for a total force of 1,260 pounds.
2. This total force is exerted by means of the piston rod, or ram, to the output section of the booster. The output section contains a hydraulic fluid. Just the end of the rod applies pressure to this fluid.
3. Let's say that the rod end has a 1" diameter. Its area is about .8 square inches. Divide the .8 square inches into the total applied force of the 1,260 pounds and the result is 1,590 pounds per square inch. We have transformed 100 PSI into 1,600 PSI, or a ratio of 16 to 1.

## HOW A BOOSTER WORKS

A booster, or pressure intensifier, is a device that amplifies available line pressure in order to perform work requiring much higher pressure. It operates a hydraulic cylinder without the need for a hydraulic power unit. A booster is basically a cylinder and is similar in internal design, except that the rod end of the piston does not extend outside. The rod becomes a ram for hydraulic fluid. A booster is equivalent to a transformer, or pulley system, in that it changes the ratio of pressure input to pressure output but does not amplify power. Low pressure air, as found in most plants or shops, is connected to the large cylinder. Pressures are typically 80 to 100 PSI. This low pressure is converted by the booster to a much higher hydraulic pressure on the output side. This discharge has an amplified pressure potential equal to the product of the supply pressure and the booster ratio. Total power is not changed, as the low pressure input air must operate against a large area piston in order to produce high pressure from a much smaller surface area.

Standard boosters are available in ratios running from approximately 2:1 up to 36:1. In the selection of a particular booster (for details, see page 143), not only does the ratio have to be taken into account, but also the output volume has to be matched to the cylinder which the booster will drive.

### What does the working cylinder see?

In our example above, we have an output of 1600 PSI hydraulic pressure. When this 1600 PSI is fed to a cylinder, the total area of the piston in the cylinder is now under a pressure of 1600 PSI! Therefore, instead of an air cylinder which would have to work under 100 PSI air pressure, we can now have a cylinder working under 1600 PSI hydraulic pressure. True, this cylinder will only perform work at this pressure through a volume of fluid in the cylinder that is equal to the same volume displacement in the booster, but for many operations, this volume displacement at such increased pressures is completely satisfactory.

### Operating power

In the example above, shop air is used as the power source, as this is the most common way boosters are used. It is, however, quite possible to use oil as the operating power source, particularly for extremely high pressure applications. For example, if you need to develop 40,000 PSI and had a choice of 80 PSI air or 3,000 PSI oil, the air booster ratio would be 500:1 and the oil only about 13:1. It's obvious that using an oil to oil booster system would be far less expensive. Standard boosters are air to oil only.

### When should boosters be used?

Typical applications for boosters are shown on page 128. Without going into a list of such applications, let's see when you are better off using a booster rather than a complete hydraulic system. Keep in mind that boosters will never replace the pump-cylinder method of work ability...nor are they intended to do so. Therefore, as a general statement, you use a booster *when intermittent high pressure is required in a limited operation, and all you have is low pressure air*. In all of the published applications, there is really no exception to this general rule. The reason for this is that boosters and cylinder combinations are not intended for rapid cycling with high pressures: i.e., their total power is limited.

Now that we've eliminated the negative, let's take the positive approach. You need to clamp a fixture into position for a work application. You have 100 psi shop air. An air cylinder operating under 100 psi will simply not hold the fixture in position in the intended application. Here's an ideal spot for a booster and hydraulic cylinder. As a plus, remember that the hydraulic cylinder can be controlled in its clamping action better than an air cylinder. By using a Dual Pressure Booster (Model BA), the clamping cylinder will travel rapidly toward the fixture, under light pressure, and then will, at the end of its travel, exert high pressure just as it clamps.

**Cost Ratio.** Another reason for using boosters is the cost ratio of a booster system vs. pump system. You have a machine which requires a linear actuator pressure of 5,000 PSI. If you were to design in a complete 5,000 PSI hydraulic system into this one machine, it could cost you many times a booster system! Again, remember that we are talking about one machine requiring intermittent high pressure.

**Long Holding Times.** Another case is where you want to exert a high pressure for a long time, such as maintaining pressures on printing rolls. A booster-cylinder system will maintain a continuous pressure with very little power input. In a pump-cylinder system, the pump must be kept in continual operation. (In order to achieve such holding pressure, there must be a relief valve inserted in the system.)

**Extreme High Pressures.** Pressures over 10,000 PSI can be obtained with special boosters while virtually impossible with ordinary rotary pumps. When you require an inexpensive way of achieving high pressure, even up to 50,000 PSI, the booster is the answer.

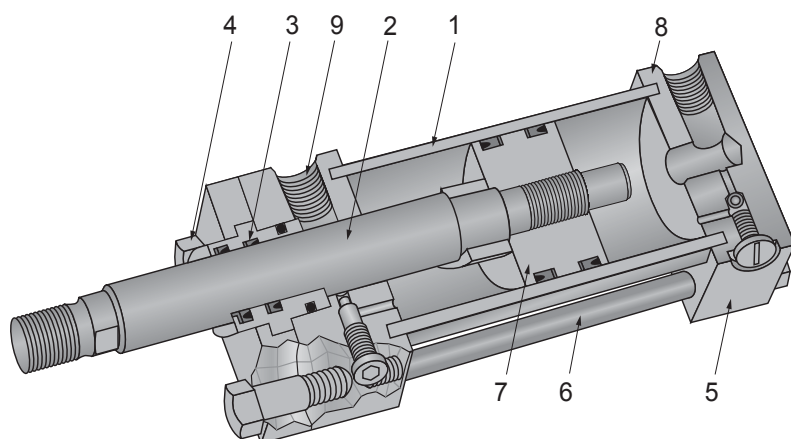

## BOOSTER FEATURES

### 1. Booster Barrel

The barrel is of steel tubing, honed to a fine finish and hard chrome plated. This provides superior sealing power, minimum friction and maximum seal life.

### 2. Rod

Made of high strength steel, induction hardened. It is grounded and polished to a low micro finish, and then chrome plated to resist scoring and corrosion, for maximum life.

### 3. Rod Seals

Rod seals are of *Milwaukee Cylinder's* high quality, stacked vee construction. They are specifically designed for high pressure hydraulic use, and their performance record has proven their long lasting, low leakage capability.

### 4. Nozzles

Steel nozzles are externally removable for replacing seals without disturbing booster assembly or tie-rod torque. Four self-locking nuts require only a standard shop wrench for removal.

### 5. End Caps

Heavy duty end caps are machined from solid, durable steel. All mountings are rigidly attached by either threading or welding. All mountings are expertly machined to provide accurate alignment on matched beds or mounting surfaces.

### 6. Tie Rods and Nuts

Tie rods are constructed from medium carbon steel, with a yield strength of 125,000 PSI. Threads are accurately machined for rigid engagement of the nuts. Nuts are high strength, self-locking type.

### 7. Piston

Precision machined from high strength iron alloy. The piston is pilot fitted and threaded to the rod. "U" cup seals are supported by back-up washers.

### 8. End Cap Seals

The barrel is sealed to the end caps with a high temperature, compression type gasket that seals over the entire face of the tube end.

### 9. Ports

Large, unrestricted ports conforming to NFPA standards are provided. They can be rotated to any 90° position in relation to each other and the booster mounting. Dry seal, national pipe threads are standard with SAE straight thread ports, oversized ports and metric ports available upon request.

Series H

Series MH

Series LH

Series A

Series MN

Hyd-Pneu Devices

## How a Dual Pressure Booster Works

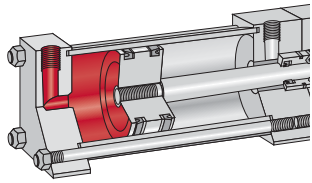

1. Low pressure air is applied to the large surface piston during the entire work stroke. The input pressure of BA Boosters is rated at 250 PSI air.

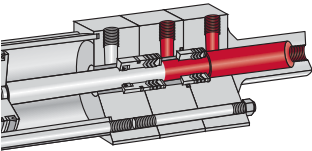

2. The rod advances through hydraulic fluid that is not yet contained under pressure. The rod is traveling under the same pressure as the air supply.

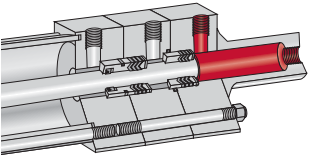

3. When the ram enters the high pressure seal, it immediately boosts the hydraulic pressure up to the rated value. Because of the extra ram seal assembly, the output pressure of this model is limited to 3,000 PSI.

## DUAL PRESSURE BOOSTERS

In *Milwaukee Cylinder's* Model BA Booster, the high pressure output is applied only after the ram has entered the secondary, or high pressure seal. This allows a low pressure approach stroke and a high pressure work stroke where the working ram travels only a short distance under high pressure, as when a part needs to be clamped in position for another operation. Model BA boosters are self bleeding and an external valve in the inlet is not required.

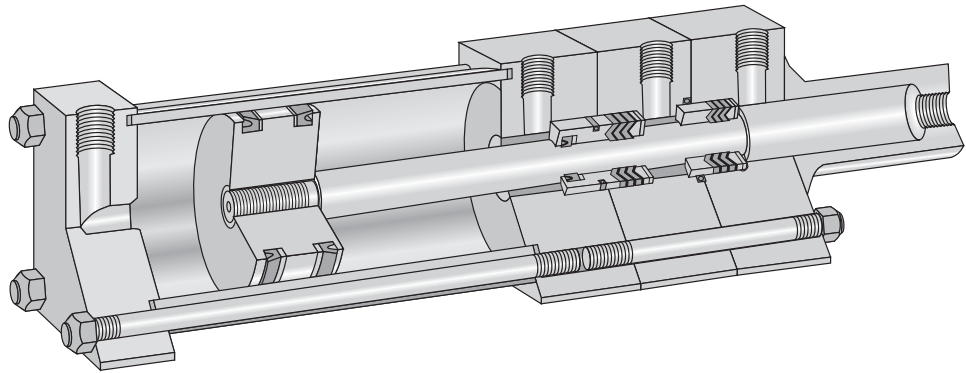

## RAPID TRAVERSE, AUTOMATIC SEQUENCING WITH BA BOOSTER

Below the circuit shows the use of a double-acting cylinder with rapid traverse at low pressure and sequencing to high pressure when the load is picked up. When the air valve is shifted, the left air-oil tank forces oil through the booster and extends the cylinder. When the load is picked up, the timer valve ports air to the booster for a high pressure output to the cylinder. On the return stroke, the right air-oil tank retracts the cylinder.

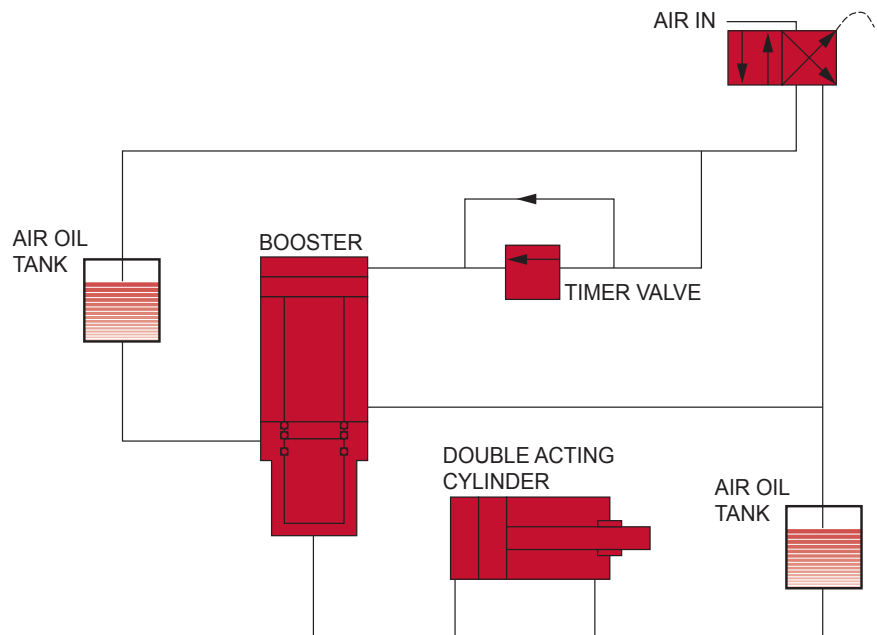

### 4-Inch Minimum Stroke

Series BA Boosters must have a minimum of 4-inches of stroke.

### MODEL BA 11 - No Tie Rod Extension

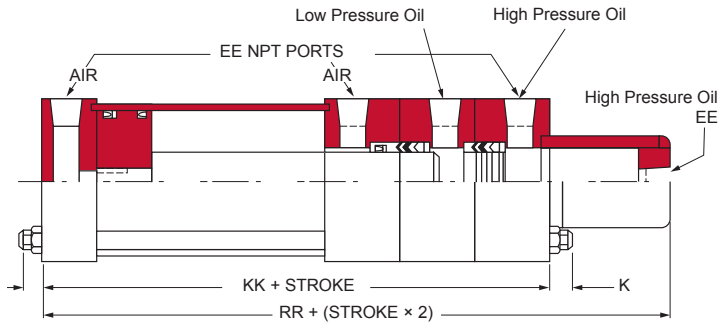

Pressure Limitation Rated Output:

**3000 psi**

Pressure Limitation Rated Input:

**250 psi**

\*Over 3000 psi, contact factory.

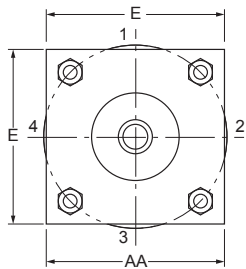

- MODEL BA 10 - Tie Rod Extended Both Ends
- MODEL BA 12 - Tie Rod Extended Rod End
- MODEL BA 13 - Tie Rod Extended Blind End

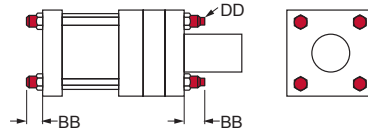

### MODEL BA 42 - Side Lug Mounting

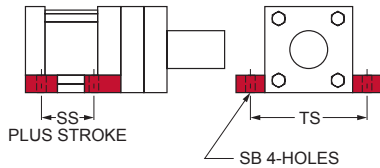

### MODEL BA 41 - Tapped Holes in Caps Flush Mounting

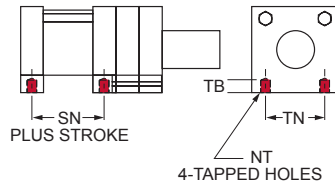

OTHER MOUNTING STYLES AVAILABLE UPON REQUEST  
ADD 2" TO REQUIRED STROKE FOR BA BOOSTERS

## ▼ TABLE BA

Bore Ø	E	K	AA	BB	DD	EE	KK	NT	RR max.	SB	SN	SS	TB	TN	TS
2½	3	7/16	3.10	1½	5/16-24	3/8	6¾	3/8-16	5¾	7/16	2¾	3	5/8	1¼	3¾
3¼	3¾	½	3.90	1¾	3/8-24	½	7¾	1/2-13	6¾	9/16	2¾	3¼	¾	1½	4¾
4	4½	½	4.70	1¾	3/8-24	½	7¾	1/2-13	6¾	9/16	2¾	3¼	1	2¼	5½
5	5½	5/8	5.80	1¾	1/2-20	½	8	5/8-11	7	1¾	2¾	3½	1	2¼	6¾
6	6½	5/8	6.90	1¾	1/2-20	¾	9	¾-10	8	1¾	3½	3¾	1½	3¼	7¾
8	8½	¾	9.10	2¾	5/8-18	¾	9½	¾-10	8½	1¾	3¼	3¾	1½	4½	9¾
10	10¾	7/8	11.20	2¾	¾-16	1	10¾	1-8	9¾	1¾	4½	4¾	1¾	5½	12¾
12	12¾	7/8	13.30	2¾	¾-16	1	11¾	1-8	10¾	1¾	4¾	5½	1½	7½	14½
14	14¾	1	15.40	3¾	7/8-14	1¼	13¾	1¼-7	12¾	1¾	5½	5¾	2¼	8¾	17

## How a Single Pressure Booster Works

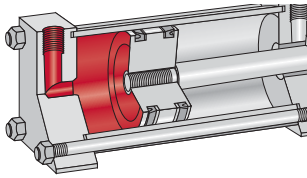

1. Low pressure air is applied to the large surface piston during the entire work stroke. The input pressure of BD Boosters is rated at 250 PSI air.

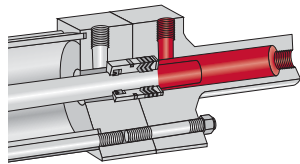

2. The rod of the BD booster is constantly under high pressure throughout the entire work stroke. It has but a single seal assembly.

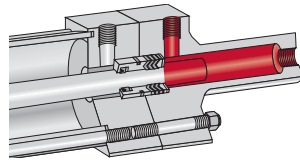

3. Oil flows out, and back in, the same port on the high pressure end of the BD booster. Make up oil is provided through an external check valve or needle valve.

## SINGLE PRESSURE BOOSTERS

Milwaukee Cylinder's Model BD Boosters are used where high pressure output is required during the entire work stroke of the cylinder. This design is used for all output pressures and exclusively with special boosters where pressures are above the normal 3,000 PSI. Its single rod seal assembly constantly surrounds the rod. Because of its simpler design, model BD is not self bleeding and more care must be taken in bleeding out air when installing.

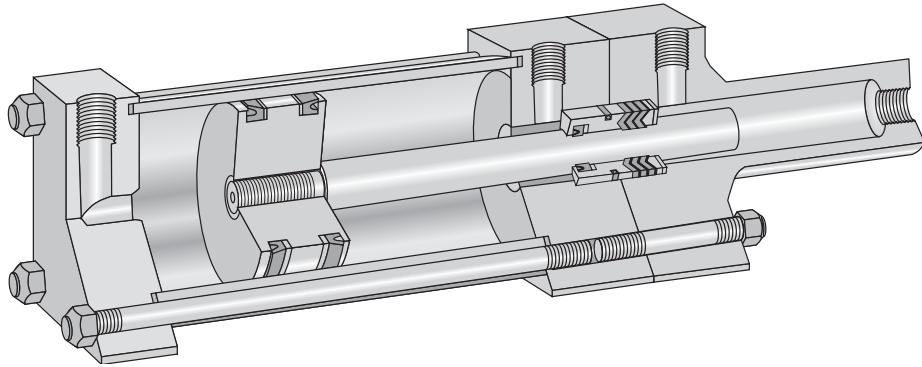

## BD BOOSTER WITH SINGLE-ACTING CLAMPING CYLINDER

The circuit shows a BD booster powering a short stroke, spring return cylinder. A simple valve on the input line to the booster can be either manually or automatically operated. Input to the booster is kept on as long as the clamping action of the cylinder is required.

Once removed, the internal spring in the cylinder returns the cylinder piston which, in turn, returns the oil to the booster port.

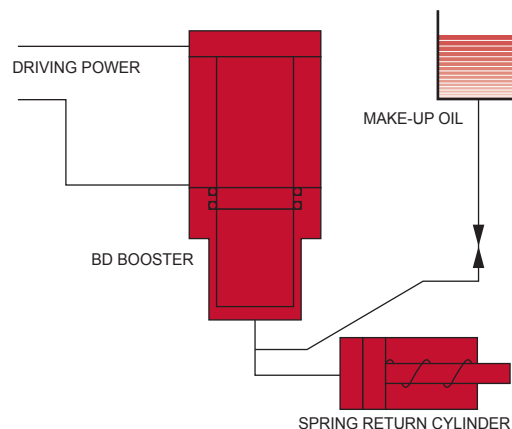

MODEL BD 11 - No Tie Rod Extension

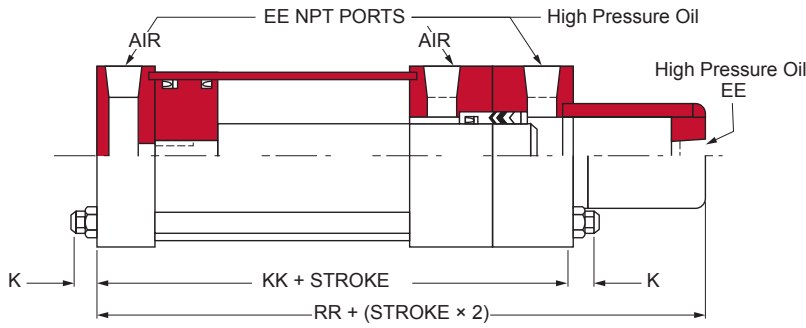

Pressure Limitation Rated Output:

**3000 psi**

Pressure Limitation Rated Input:

**250 psi**

\*Over 3000 psi, contact factory.

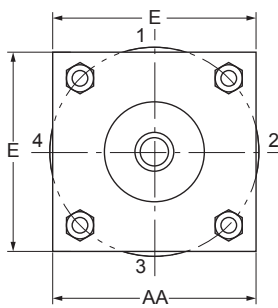

- MODEL BD 10 - Tie Rod Extended Both Ends
- MODEL BD 12 - Tie Rod Extended Rod End
- MODEL BD 13 - Tie Rod Extended Blind End

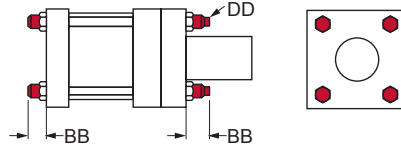

MODEL BD 42 - Side Lug Mounting

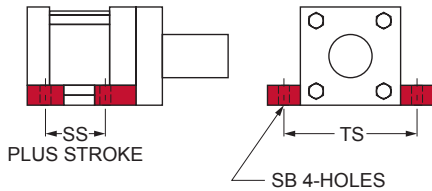

MODEL BD 41 - Tapped Holes in Caps Flush Mounting

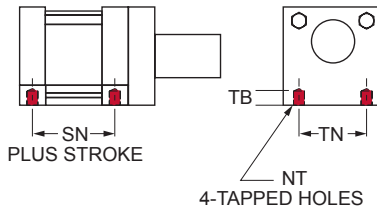

OTHER MOUNTING STYLES AVAILABLE UPON REQUEST

▼ TABLE BD

Bore Ø	E	K	AA	BB	DD	EE	KK	NT	RR max.	SB	SN	SS	TB	TN	TS
2½	3	7/16	3.10	1½	5/16-24	¾	5¼	¾-16	6	7/16	2¾	3	5/8	1¼	3¾
3¼	3¾	½	3.90	1¾	¾-24	½	6	½-13	6½	9/16	2⅝	3¼	¾	1½	4¾
4	4½	½	4.70	1¾	¾-24	½	6	½-13	7¼	9/16	2⅝	3¼	1	2¼	5½
5	5½	5/8	5.80	1⅞	½-20	½	6¼	5/8-11	7¾	1¾	2⅞	3⅝	1	2⅞	6⅞
6	6½	5/8	6.90	1⅞	½-20	¾	7	¾-10	8½	1¾	3⅝	3⅝	1⅞	3¼	7⅞
8	8½	¾	9.10	2⅞	5/8-18	¾	7⅞	¾-10	8½	1¾	3¼	3¾	1⅞	4½	9⅞
10	10⅝	7/8	11.20	2⅞	¾-16	1	8⅝	1-8	9⅞	1⅞	4⅞	4⅞	1⅞	5½	12⅞
12	12¾	7/8	13.30	2⅞	¾-16	1	9⅞	1-8	9⅞	1⅞	4⅞	5⅞	1½	7¼	14½
14	14¾	1	15.40	3⅞	7/8-14	1¼	10⅞	1¼-7	11⅞	1⅞	5½	5⅞	2¼	8⅞	17

## Save Space and Weight

In many applications, booster driven cylinders can replace an extremely large, low pressure air cylinder with a small, efficient, high pressure hydraulic cylinder. Coupled with reduced circuitry, the overall weight of a machine can be reduced, as well as the total space required.

## Lower Cost

A booster system is less expensive than an overall hydraulic system with its pump-motor requirements. They also require only a fraction of the air of a direct cylinder installation. Hydraulic requirements are also much smaller to operate a given function.

## Smoother Power

Compared to air, boosters provide work cylinders with the smooth, efficient power of a hydraulic installation. When such power is required, and installations are limited to smaller volumes, boosters are ideal.

## Points of Consideration

1. Plant air distribution system must be capable of maintaining the required pressure to the booster.
2. Regulators should be the relieving type. A leaky poppet could result in a dangerous pressure rise.
3. Directional control valves and air conditioners should have ports at least as large as the booster.
4. Always bleed air from the hydraulic circuit when installing booster systems. Type BA boosters are self bleeding.

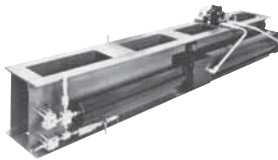

A Milwaukee Cylinder designed special booster featuring a 10" bore, 60" stroke and a 5½" rod. This booster, mounted on the side of a steel "I" beam, converts a 3,000 psi oil input to an 8,000 PSI output of an ethylene-glycol solution with a total high pressure displacement of 1,400 cubic inches. The booster also had to be designed to operate over a temperature range from -65° to +100° F.

## APPLICATIONS FOR BOOSTERS

### High Pressure From Shop Air

One of the principle applications for boosters is in the conversion of low pressure shop air to high pressure hydraulic operation for a specific function where a hydraulic cylinder is required. Many operations require the smooth power inherent in a hydraulic cylinder, yet do not require the expenditure for a complete hydraulic installation. The small, yet powerful movement of a booster driven hydraulic cylinder can be used to hold a piece for riveting, as a spot welding clamp, for punching, piercing, forming, crimping, bending, stamping, shearing, marking, etc. The complete installation of a booster, air-oil tank and cylinder can be mounted directly on the equipment itself.

### Testing

Testing of manufactured parts for physical strength, leaks or burst rating can easily be accomplished with a booster-cylinder combination or a booster alone. A hydraulic cylinder will give a precise, high pressure force for mechanical testing, and a booster can be linked up directly, to a die casting, for instance, to test for leaks.

### Fluid Transfer

Fluids that are difficult or impossible to transfer with a conventional pump can be fed through a valve-booster combination. Depending on the type of fluid, boosters can be produced with special metals, such as stainless steel.

### Liquid Injection

High pressure injection of liquids are readily handled with a booster. Such liquids, injected into high pressure gas lines or containers, might include lubricants, antifreeze or odorants.

### Holding Pressures

Long holding pressures required in vulcanizing, laminating, bonding or curing can be readily maintained without drawing power or generating heat, except for making up any leakage loss.

A booster can maintain accurate pressure levels under such static conditions for an indefinite time.



### High Pressures

Extremely high pressure, up to 50,000 psi, have been achieved with special boosters. Such high pressures would be impossible with an ordinary hydraulic rotary pump.

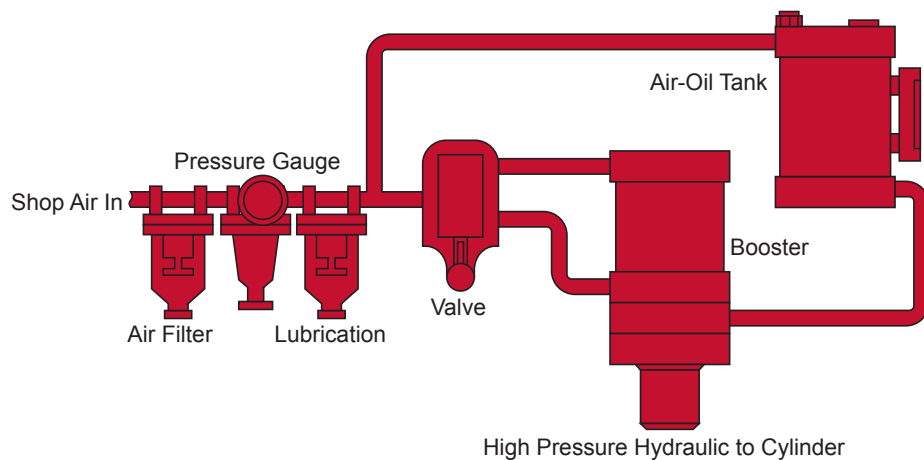



## DETERMINING CORRECT BOOSTER SIZE

Booster size is determined by the high pressure load of the cylinder. In a single pressure system (Model BD), the entire cylinder stroke is the load cycle. In a dual system (Model BA), only the power stroke of the cylinder is considered in the booster calculation.

1. Based on load requirements, select a cylinder bore size that will provide an adequate safety margin.

**Example: Load: 4500 lbs. From the cylinder selector chart, choose a thrust of 4909 lbs. Cylinder bore is therefore 2½", and input pressure is 1,000 PSI.**

2. Knowing the stroke required for the cylinder, calculate the volume of oil required for full extension under load pressure. This is the piston area times cylinder stroke. It is important to note that the required volume should not be underestimated. Therefore, add a minimum of 25% to the calculated volume as a safety factor.

**From the cylinder chart, area is 4.909 in<sup>2</sup>. (You require a 2" stroke.)**

**Volume = 4.91 x 2 x 1.25 = 12.25 in<sup>3</sup>**

3. Divide the hydraulic system pressure by the available shop air pressure to determine booster ratio.

**Booster Ratio = 1000/80 = 12.5**

4. From the booster ratio chart, select the required booster bore and rod sizes that will safely handle the booster ratio.

**A booster ratio of 13.22 adequately covers the 12.5 ratio requirement.**

**This gives the booster with a bore of 5" and a rod with a diameter of 1¾". Reading down on the chart, the volume per in. of stroke is 1.49.**

5. To determine the booster stroke, divide the calculated high pressure oil volume (from section 2) by the vol/in of stroke. Add 2" for a BA booster.

**Stroke = 12.28/1.49 + 2 = 10.24"**

From the above, you specify a cylinder with a bore of 2½" and a stroke of 2". You specify a booster with a 5" bore, a 1¾" rod and a 10¼" stroke. From this information, you can determine specific mounting dimensions for BA boosters on page 139. (Other bore and rod combinations will also do the job.)

## ▼ Cylinder Requirements

Push stroke force in pounds  
Pressures of operating medium

Cylinder Bore Ø	Piston Area Sq In.	50 PSI	60 PSI	80 PSI	100 PSI	200 PSI	250 PSI	500 PSI	750 PSI	1000 PSI	1500 PSI	2000 PSI	3000 PSI
1½	1.767	88	106	141	177	353	442	884	1,325	1,767	2,651	3,534	5,301
2	3.142	157	189	251	314	628	786	1,571	2,357	3,142	4,713	6,283	9,426
2½	4.909	245	295	393	491	982	1,227	2,455	3,682	4,909	7,364	9,818	14,727
3¼	8.296	415	498	664	830	1,659	2,074	4,148	6,222	8,296	12,444	16,592	24,888
4	12.566	628	754	1005	1,257	2,513	3,141	6,283	9,425	12,566	18,849	25,132	37,698
5	19.635	982	1,178	1,571	1,964	3,927	4,909	9,818	14,726	19,635	29,453	39,270	58,905
6	28.274	1414	1,696	2,262	2,827	5,657	7,071	14,137	21,205	28,274	42,411	56,548	84,822
7	38.485	1,924	2,309	3,079	3,849	7,697	9,621	19,242	28,864	38,485	57,728	76,970	115,455
8	50.265	2513	3,016	4,021	5,027	10,053	12,566	25,133	37,699	50,265	75,398	100,530	150,795
10	78.54	3,927	4,712	6,283	7,854	15,710	19,635	-	-	-	-	-	-
12	113.10	5655	6,786	9,048	11,310	22,620	28,275	-	-	-	-	-	-
14	153.94	7697	9,236	12,315	15,394	30,790	38,435	-	-	-	-	-	-
16	201.60	10,053	12,064	16,085	20,106	40,210	-	-	-	-	-	-	-
18	254.47	12,723	15,268	20,358	25,447	50,890	-	-	-	-	-	-	-
20	314.16	15,708	18,850	25,133	31,416	62,830	-	-	-	-	-	-	-

## ▼ Booster Selection

Booster Ratios  
(Condensed Selector Chart for input pressures of 100 psi on page 144.)

Booster Bore Ø	Ram Sizes												
	5/8	1	1 1/8	1 1/4	2	2 1/2	3	3 1/2	4	4 1/2	5	5 1/2	
2½	16.00	6.25	-	-	-	-	-	-	-	-	-	-	-
3¼	-	10.56	5.59	3.45*	2.64*	-	-	-	-	-	-	-	-
4	-	16.00	8.46	5.22	4.00	2.56	-	-	-	-	-	-	-
5	-	25.00	13.22	8.16	6.25	4.00	2.78	2.04	-	-	-	-	-
6	-	-	19.04	11.76	9.00	5.76	4.00	2.94	2.25*	-	-	-	-
8	-	-	33.85	20.90	16.00	10.24	7.11	5.22	4.00	3.16	2.56	2.12	-
10	-	-	-	32.65	25.00	16.00	11.11	8.16	6.25	4.94	4.00	3.31	-
12	-	-	-	-	36.00	23.04	16.00	11.75	9.00	7.11	5.76	4.76	-
14	-	-	-	-	-	31.36	21.78	16.00	12.25	9.68	7.84	6.48	-
Vol. Output /in stroke	.31	.78	1.49	2.40	3.14	4.91	7.07	9.62	12.57	15.90	19.63	23.76	-

\*Not available in BA41 or BD41 mount.

Series H

Series MH

Series LH

Series A

Series MN

Hyd-Pneu Devices

## BOOSTER BORE & ROD DIAMETERS

The following chart quickly provides booster bore and rod diameters for basic discharge pressures when the input pressure is 100 PSI. Example: if required pressure to cylinder is 1500 PSI, read down column and select any rod and bore diameter desired, such as a 3" rod and a 12" bore. The left column shows that a displacement of 7.07 in<sup>3</sup> per inch of stroke will result. Other combinations can, of course, be chosen at a glance for the most economical booster or for a booster that fits the installation requirements.

## ▼ BOOSTER SELECTION CHART (at input pressure of 100 psi)

Displacement per inch of Stroke (in <sup>3</sup> )	Minimum Discharge Pressure				Rod Ø
	500	1000	1500	3000	
.31	–	–	2½	–	5/8
.78	2½	3¼	4	–	1
1.49	3¼	5	6	8	1½
2.40	4	6	–	10	1¾
3.14	5	–	8	12	2
4.91	6	8	10	14	2½
7.07	8	10	12	–	3
9.62	8	12	14	–	3½
12.57	10	–	–	–	4
15.90	12	–	–	–	4½
19.63	12	–	–	–	5
23.76	14	–	–	–	5½
<b>Bore Size</b>					

Maximum Pressure:

### 250 psi

Max. Hydraulic Fluid Temperature:

### 400° F (205° C)

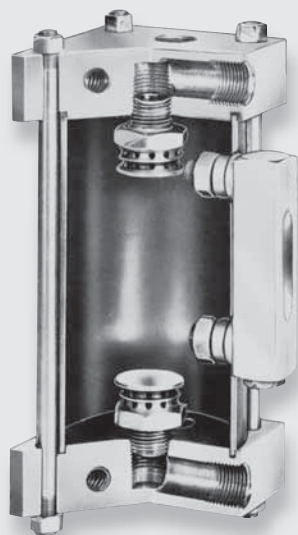

## MILWAUKEE CYLINDER AIR OIL TANKS

Air-Oil Tanks serve several purposes in a booster system:

- They are used as a source of oil to compensate for any loss in the hydraulic system
- They can provide hydraulic pressure to return the cylinder to its starting position
- They provide an outlet for entrapped air in the hydraulic system.

The Air-Oil Tank literally contains air on top of oil. The air is under line pressure from the same source as the air used to operate the booster. A sight-gauge is mounted on the side of *Milwaukee Cylinder* Air-Oil Tanks so that the level of oil in reserve can be readily observed. When required, hydraulic fluid may be added through a port in the top of the tank after shutting off air pressure.

**Features:** *Milwaukee Cylinder* Air-Oil Tanks are manufactured with the same care and high quality materials as are all *Milwaukee Cylinder's* Boosters and Cylinders. Maximum pressure for these tanks is 250 psi. They are suitable for all hydraulic fluids up to 200° F (93° C). *Milwaukee Cylinder* Air-Oil Tanks incorporate the following high quality features:

- High strength, solid steel end caps with large fill and drain plugs for fast circuit filling
- Steel tubing sealed to each end cap with compression type gaskets
- Replaceable sight gauge enclosed in aluminum shield for maximum gauge protection
- A unique baffle system, inside both end caps, assures rapid intake and discharge with a minimum of churning, foaming and aeration.

## Booster & Air-Oil Combination

By specifying a combination of a booster and air-oil tank, savings are obtained in space, cost and installation time. Tanks are mounted directly on the booster, using a common end plate and tie-rods. Due to the fact that air-oil tanks must always be used vertically, this combination is limited to a vertically mounted installation.

When ordering this combination, specify BAT or BDT depending upon whether a BA or BD booster is used. Tanks are selected with the same size bore as the booster. When determining length, subtract one "J" length from the overall combined length of the individual booster and tank lengths.

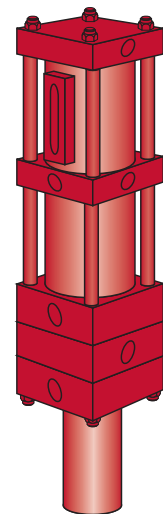

**SELECTING A TANK SIZE**

If the tank is used as a source of pressure to return the cylinder, its size must be in excess of the total cylinder displacement, otherwise, oil will be injected into the air line. Tanks should also be large enough to replenish any hydraulic losses without the necessity of adding fluid too frequently. In the chart below, always select a tank volume equal to or slightly greater than the cylinder volume. After the cylinder volume is determined, it can be located on the chart. Note that a selection may be made with varying tank diameters and lengths. (If a booster-tank combination is required, select the tank diameter to match the booster diameter.)

**▼ AIR OIL TANK SELECTION CHART**

Tank Bore Ø (in)	Usable oil volume in <sup>3</sup>	Tank Length (in)																		
		6	7	8	9	10	11	12	13	14	15	16	17	18	19	20	21	22	23	24
3¼	26	32	37	44	51	59	66	73	80	88	95	102	109	117	124	131	139	146	153	
4	39	48	56	67	78	89	100	111	122	133	144	155	166	177	188	199	210	221	232	
5	61	76	88	105	122	139	157	174	191	208	225	243	260	277	294	311	328	346	363	
6	88	109	127	152	176	201	226	250	275	300	325	349	374	399	424	448	473	498	523	
8	157	195	226	270	314	358	402	446	490	534	578	622	666	710	754	798	841	885	929	
10	245	304	353	422	490	559	628	697	765	834	903	971	1040	1109	1178	1246	1315	1384	1453	
12	353	438	509	607	706	805	904	1003	1102	1201	1300	1399	1498	1597	1696	1795	1894	1993	2092	
14	481	597	692	827	962	1096	1231	1366	1500	1635	1770	1905	2039	2174	2309	2443	2578	2713	2847	
Fluid Working Height (in)		3⅞	3⅞	4½	5⅝	6¼	7⅞	8	8⅞	9¼	10⅝	11½	12⅝	13¼	14⅞	15	15⅞	16¾	17⅝	18½

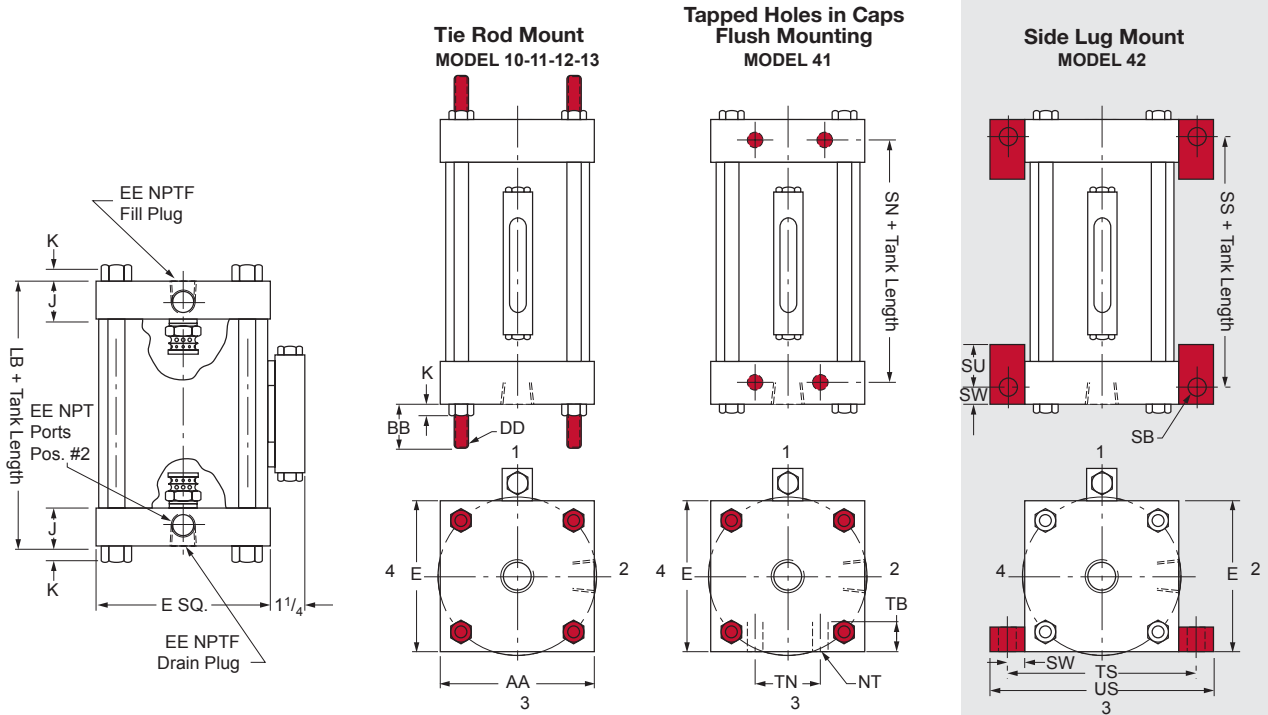

**▼ AIR OIL TANK DIMENSIONAL CHART**

Tank Bore Ø (in)	E	J	K	AA	BB	DD	EE (NPTF)	LB	NT	SB	SN	SS	ST	SU	SW	TB	TN	TS	US
3¼	3¼	1¼	⅜	3.90	1⅝	⅜-24	½	2½	1/2-13	9/16	1⅝	1½	¾	1¼	½	¾	1½	4¾	5¾
4	4½	1¼	⅜	4.70	1⅝	⅜-24	½	2½	1/2-13	9/16	1⅝	1½	¾	1¼	½	1	2⅛	5½	6½
5	5½	1¼	7/16	5.80	1⅜	½-20	½	2½	5/8-11	13/16	1⅝	1⅝	1	1⅞	11/16	1	2⅛	6⅞	8¼
6	6½	1½	7/16	6.90	1⅜	½-20	¾	3	¾-10	13/16	1⅝	1⅝	1	1⅞	11/16	1⅞	3¼	7⅞	9¼
8	8½	1½	9/16	9.10	2⅞	⅝-18	¾	3	¾-10	13/16	1⅝	1⅝	1	1⅞	11/16	1⅞	4½	9⅞	11¼
10	10⅝	2	11/16	11.20	2⅞	¾-16	1	4	1-8	11/16	2	2¼	1¼	2	7/8	1⅞	5½	12⅞	14⅞
12	12¾	2	11/16	13.30	2⅞	¾-16	1	4	1-8	11/16	2	2¼	1¼	2	7/8	1½	7¼	14½	16¼
14	14¾	2¼	13/16	15.40	3⅞	7/8-14	1¼	4½	1¼-7	15/16	2⅞	2¼	1½	2½	1⅞	2¼	8⅞	17	19¼

Series H

Series MH

Series LH

Series A

Series MN

Hyd-Pneu Devices

Operating Pressure:

**3000 psi**

Proof Pressure:

**6000 psi**

Operating Temperature:

**-20°F to +250°F**

## NA SERIES ACCUMULATORS

Nitrogen-over-oil Accumulators are designed for use over a wide range of industrial applications. Built to the same high quality standards maintained on Milwaukee Cylinder Air and Hydraulic Cylinders, Series NA Accumulator can be applied to:

- Simplify hydraulic circuit design
- Lower the hydraulic circuit horsepower requirements
- Improve hydraulic system operation
- Provide exceptionally fast cycle operation when in operation

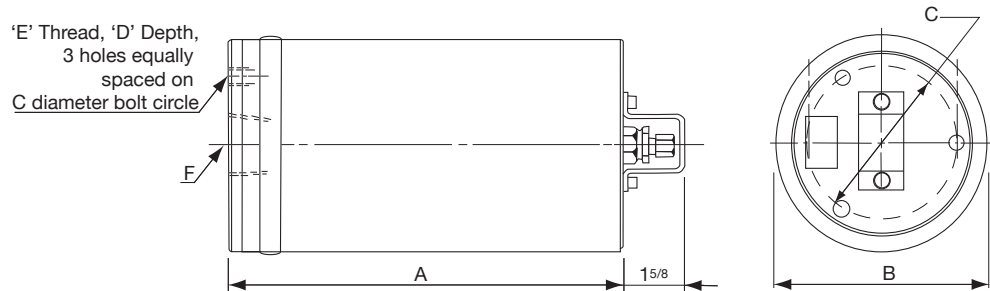

## ▼ Dimensional Data & Repair Kits

Cylinder Code	Model No.	Size	Oil Capacity in <sup>3</sup> /min	Gas Capacity in <sup>3</sup> /min	Length A	Ø B	Ø C	Thread Hole Depth D	Thread E	Port *F NPT	Seal Kit Code
3502-1005	<b>NA2 - 05</b>	½ Pint	14.5	16.2	8						
3502-1001	<b>NA2 - 1</b>	Pint	29	30.7	12¾	2¾	-	-	-	-	3502-0-40
3502-1002	<b>NA2 - 2</b>	Quart	58	59.7	22						
3504-1002	<b>NA4 - 2</b>	Quart	58	70	9¾						
3504-1004	<b>NA4 - 4</b>	½ Gal	116	128	14½						
3504-1008	<b>NA4 - 8</b>	1 Gal	231	243	23¾	4¾	3¾	½	½ - 20	1¼	3504-0-40
3504-1012	<b>NA4 - 12</b>	1½ Gal	347	359	32¾						
3504-1016	<b>NA4 - 16</b>	2 Gal	462	474	41¾						
3506-1008	<b>NA6 - 8</b>	1 Gal	231	273	15¾ <sub>16</sub>						
3506-1012	<b>NA6 - 12</b>	1½ Gal	347	388	19¼						
3506-1016	<b>NA6 - 16</b>	2 Gal	462	503	23¾ <sub>16</sub>	7	4¾	¾	¾ - 18	1½	3506-0-40
3506-1020	<b>NA6 - 20</b>	2½ Gal	578	619	27½						
3506-1032	<b>NA6 - 32</b>	4 Gal	924	965	39¾						
3506-1040	<b>NA6 - 40</b>	5 Gal	1155	1196	47¾						
3508-1040	<b>NA8 - 40</b>	5 Gal	1155	1226	33¾						
3508-1062	<b>NA8 - 62</b>	7½ Gal	1730	1801	44	9½	5¾	1	¾ - 16	2	3508-0-40
3508-1080	<b>NA8 - 80</b>	10 Gal	2310	2381	55¾						

\* Available with SAE straight thread; O-Ring port at no additional cost.

## ▼ Alternate 2000 PSI Models

Model No.	Size	Oil Capacity in <sup>3</sup> /min	Gas Capacity in <sup>3</sup> /min	Length A	Ø B	Ø C	Deep D	Thread E	Port *F NPT
<b>LA7 - 40</b>	5 Gal	1155	1210	39½					
<b>LA7 - 62</b>	7½ Gal	1730	1790	54½	8	5	1	¾ - 16	2
<b>LA7 - 80</b>	10 Gal	2310	2370	69½					
<b>LA8 - 40</b>	5 Gal	1155	1226	33¾					
<b>LA8 - 62</b>	7½ Gal	1730	1801	44	9¼	5¾	1	¾ - 16	2
<b>LA8 - 80</b>	10 Gal	2310	2381	55¾					

\* Available with SAE straight thread; O-Ring port at no additional cost.

## NA SERIES PISTON-TYPE ACCUMULATORS

### DESIGN FEATURES

Milwaukee Cylinder's Series NA Piston-Type Accumulators are of a sturdy, compact, cylindrical design, built to provide dependable performance at long service life. Series NA features:

1. Honed steel barrel, welded to the hydraulic steel end cap.
2. Solid steel gas end cap, screwed in place for easy removal and seated with O-ring and back-up washer.
3. Lightweight, low inertia aluminum piston, reducing bounce, over travel, and shock when in operation.
4. Non-metallic wear rings provide piston to wall contact. Non-scoring, low frictional drag, these scarf cut rings also stop shock waves from reaching primary seal. The wear rings also provide a wiper type action, thus protecting the primary seal.
5. Proven O-ring balanced seal design with double back-up anti-extrusion rings.
6. Protected gas fill valve. This valve also incorporates a release valve for quick exhausting of the pre charge gas.

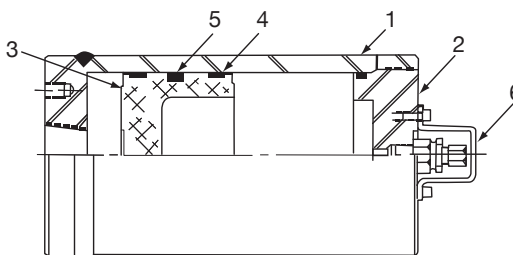

### APPLICATION

Milwaukee Cylinder's Series NA Piston-Type Accumulators have a wide range of applications such as:

- Cushioning peak loads
- Shock absorption
- Compensating for circuit leakage
- Maintaining constant loading on holding circuits
- Performing extremely fast cylinder cycles
- Reducing pump size and circuit horsepower
- A safety device—in case of pump failure—Hydraulic power is available to activate brakes or other locking devices.

Determination of the usable volume of oil obtained from a specific size Accumulator, under specific operating conditions, can be computed by using the formula  $P_1 V_1 = P_2 V_2$  (Isothermal) where:

$P_1$  = absolute precharge pressure  
(Gauge + 14.7) psia

$V_1$  = Initial gas volume cubic inch

$P_2$  = Final pressure psia

$V_2$  = Final gas volume cubic inch

Compute  $V_2$  volume for both maximum and minimum operating pressure, ( $P_2$ ). Subtracting the  $V_2$  volume from the Accumulator total gas volume will result in the Accumulator oil volumes at both operating pressure limits. The difference between the two resulting oil volumes, is the usable volume of Accumulator oil.

### PART LIST

When ordering parts specify Model No., Part No., Description, Serial No. and Quantity.

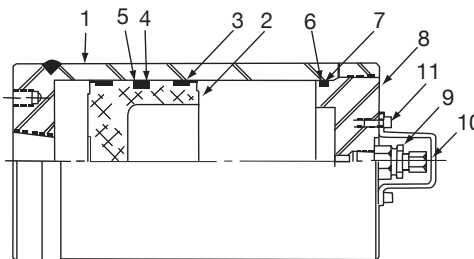

Part No.	Description	Qty.
1	Accumulator Shell	1
2	Piston	1
3	Wear Ring	2
4	O-Ring (Piston)	1
5	Backup Washer	2
6	O-Ring (End Cap)	1
7	Backup Washer	1
8	End Cap	1
9	Gas Valve	1
10	Bracket	1
11	Cap Screws	2

### EXAMPLE FOR NA 4-4

Gas Capacity: 128 cubic inches

Operating Pressure Range:

1500 to 2200 psi

Pre-charge Pressure: 800 psi

@ 2200 psi

$$P_1 V_1 = P_2 V_2$$

$$814.7 \times 128 = 2214.7 \times V_2$$

$$V_2 = 47.2 \text{ cu.in. gas}$$

$$V_1 - V_2 = 81.2 \text{ cu.in. oil}$$

@ 1500 psi

$$814.7 \times 128 = 1514.7 \times V_2$$

$$V_2 = 68.5 \text{ cu.in. gas}$$

$$V_1 - V_2 = 59.5 \text{ cu.in. oil}$$

Usable Oil Volume

$$81.2 - 59.5 = 21.7 \text{ cu.in.}$$

(Based on Isothermal performance)

### SPECIAL UNITS

Milwaukee Cylinder can supply you an Accumulator to do your job.

Accumulators for:

1. Fire-resistant fluids
2. Water operation
3. High pressure
4. High and low temperature operation
5. Special flange mounts for direct connection to check valves or manifold mounts.

These are some of the special applications which are available.

Contact your local Milwaukee Cylinder representative or the factory direct with your requirements.

Series H

4-35 Series H  
Heavy Duty  
Hydraulic  
Cylinders

Series MH

36-49 Series MH  
ISO Metric  
Hydraulic  
Cylinders

Series LH

50-71 Series LH  
Low Pressure  
Hydraulic  
Cylinders

Series A

72-101 Series A  
Pneumatic  
Cylinders

Series MN

102-134 Series MN  
Aluminum  
Cylinders

Hyd-Pneu Devices

135-147 Hydraulic  
Pneumatic  
Devices

Cyl Accessories

148-153 Cylinder  
Accessories

Manipulators

154-159 Industrial  
Manipulators

Power Units/Valves

160-176 Power Units  
and Valves

Design Guide

177-193 Design  
Engineering  
Guide

*milwaukee*  
**Cylinder**

5877 S. Pennsylvania Avenue  
Cudahy, Wisconsin 53110-2456 USA



Your *Milwaukee Cylinder* Distributor



[www.webtec.com](http://www.webtec.com)